

# Fire Hydrant Parts List

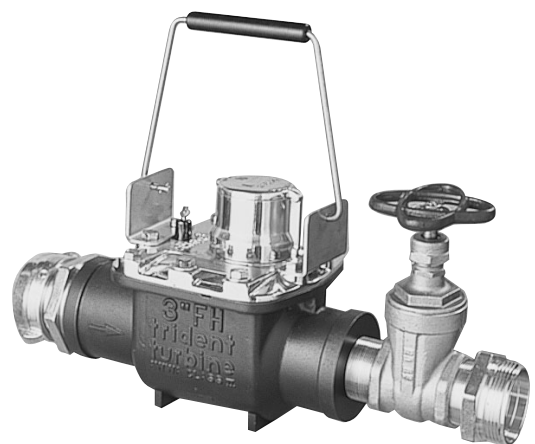

ITEM	DESCRIPTION	PART NUMBER	QUANTITY
1	16" Seal Wire with Lead Seal	41110-501	1
2	Seal Cap	11098-001	1
3	Calibration Nut	8545-417	1
4	Maincase Bolts	8329-405	10
5	Cover	9639-104	1
6	Drive Spindle Assembly	9485-001	1
7	Calibration Vane Assembly	11097-200	1
8	Drive Sleeve	9484-006	1
9	Compression Spring	N/A	N/A
10	Measuring Chamber Assembly	9439-021SP00	1
11	Washer	8568-012	4
12	Bolts	8329-007	4
13	Maincase Gasket	8341-304	1
*14	Gasket	8340-029	1
15	Fire Hose Coupling Assembly	9631-002	1
16	Maincase	9630-002	1
17	Bracket/Handle Assembly	12163-000	1
18	Nipple	8314-701	1
19	Gate Valve	8368-011	1
20	Outlet Nipple	N/A	1
21	Cover Assembly	9482-003	1

\*Item #14 is included in assembly.

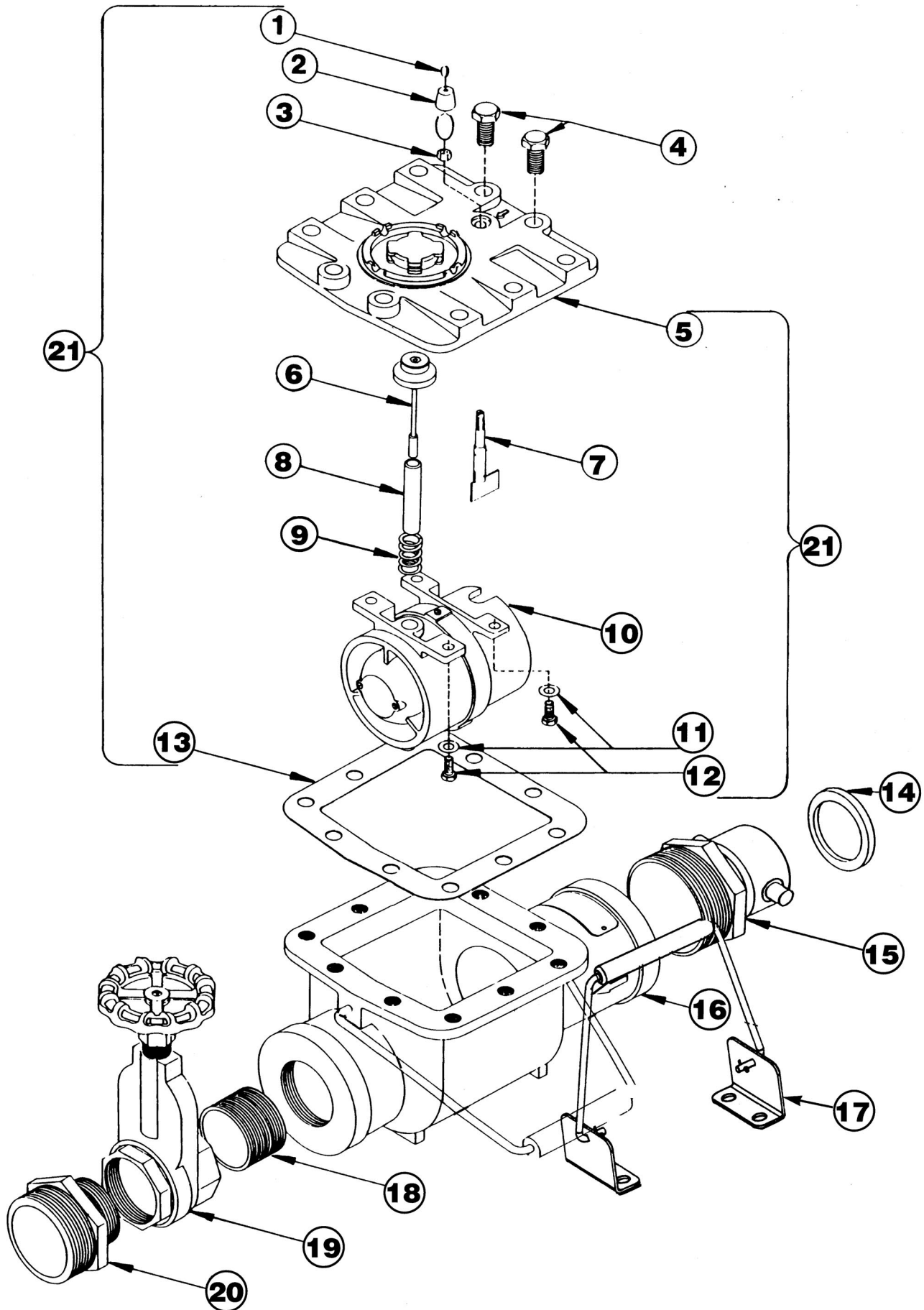

(Kit Includes: Register, Gasket, Cover, and Rotor Assembly)

REGISTRATION	KIT NUMBER	REGISTER COMPLETE*	ROLL-SEALED REGISTER ASSEMBLY
10 cu. ft.	9600-101	R83F8	9107-422
100 U.S. gal.	9600-201	R83G8	9107-421
1 M <sup>3</sup>	9600-501	R83M8	9107-423

\*When ordering registers, you must include change gear combination or four-digit register code on dial face.

Neptune engages in ongoing research and development to improve and enhance its products. Therefore, Neptune reserves the right to change product or system specifications without notice.

**Neptune Technology Group Inc.**

1600 Alabama Highway 229  
Tallahassee, AL 36078  
USA  
Tel: (800) 645-1892  
Fax: (334) 283-7293

**Neptune Technology Group (Canada) Ltd.**

7275 West Credit Avenue  
Mississauga, Ontario  
L5N 5M9  
Canada  
Tel: (905) 858-4211  
Fax: (905) 858-0428

**Neptune Technology Group Inc.**

Ejército Nacional No. 418  
Piso 12, Desp. 1201-1202  
Col. Chapultepec Morales  
Delegación Miguel Hidalgo  
11570 México, Distrito Federal  
Tel: (525) 55203 5294 / (525) 55203 5708  
Fax: (525) 55203 6503



**NEPTUNE**  
TECHNOLOGY GROUP

[neptunetg.com](http://neptunetg.com)